

CURRENT PROJECTS AND RESEARCH ACTIVITIES

1. Treatment and recovery of incinerator bottom ash

Incinerator bottom ash (IBA) is the solid residue of waste-to-energy plants, consisting mainly of mineral and metal fractions, which are non-combustible materials that are left over after combustion. Both the mineral and metal fractions can be recovered and used as secondary raw material for new applications. This research project aims at outlining the state-of-the-art bottom ash recovery in Italy and Europe by first investigating the existing technologies for treatment and the different applications for the recovered materials. Then, an experimental phase will be conducted to evaluate the effects of the various extracting technologies (dry and wet) on the quantity and quality of recoverable materials. Finally, an economic and environmental (through LCA) analysis will be carried out to identify the best treatment practices.



Mineral fraction of bottom ash



Metal fraction of bottom ash

2. Environmental analysis of Construction and Demolition Waste management in Lombardy region through Life Cycle Assessment

This research project examines the environmental burdens and benefits associated with the Construction and Demolition Waste (CDW) management and recycling system currently implemented in Lombardy Region (Italy) from a life cycle perspective, in order to identify strategic actions to improve it. The project is funded by the regional government, i.e. the authority in charge of waste management planning.

The aim is to support Regione Lombardia in designing a more sustainable and resource-efficient system based on a comprehensive and scientific-based methodology through Life Cycle Assessment (LCA). The project has been carried out through five tasks:

- 1) In-depth analysis of the current CDW management in Lombardy region: official CDW data has been elaborated to estimate the amount and composition of CDW generated and treated and to define the mass balance of the whole CDW management system, in terms of CDW landfilled, recovered and stored in transfer stations, with reference to the year 2014.
- 2) Primary data collection on CDW recovery technology: technical visits at some selected CDW treatment facilities have been carried out in order to improve the knowledge of treatment processes actually applied and to collect primary data on recovery efficiencies and on consumption of energy and auxiliary materials. In this way, an LCA inventory dataset specific for the analysed geographical context was created.
- 3) Evaluation of the quality of secondary products obtained from CDW and their actual use: a focus has been made on the technical characteristics and the actual market of the recycled aggregates from CDW. Based on this information, the type and amount of "avoided natural materials" that can be replaced by recycled products have been estimated. The environmental benefits due to the "avoided impacts" have been quantified using primary data collected from quarry sites across the region.

- 4) Definition of alternative scenarios: the interpretation of LCA results of the current scenario, together with a literature review aimed at defining state-of-the-art treatment technologies, have been used to identify possible alternative CDW management strategies, innovative processes and/or alternative recovery solutions (i.e. "alternative scenarios").
- 5) Formulation of recommendations: comparative LCA analyses of the alternative scenarios have been performed to quantify the benefits arising from the suggested improvements. Results have been used to provide recommendations to the regional authorities to enhance the whole CDW recycling chain.

Mixed C&D waste



Recycled fine aggregate (0/10)



Concrete recycled aggregate (0/63)



Coarse recycled aggregate 25/63



Recycled aggregate in a single fraction (0/63)



Mixed CDW and different fractions according to their granulometry

3. Improving the modelling of avoided products in waste-management-oriented LCA

To achieve the ambitious quantitative recycling targets set by the European circular economy package for the year 2030, the qualitative characteristics of and the existence of a market for recycled materials must be addressed, especially as higher recycling rates imply that more and more hardly recyclable materials will be collected together with the easily recyclable ones. This research therefore aims to stimulate the discussion and advance the knowledge of modelling avoided material products in waste-management-oriented Life Cycle Assessment (LCA) studies.

This study includes a comprehensive explanation of the down-cycling phenomena that results in a lower quality of recycled materials compared to the corresponding virgin ones and is reported for important materials such as paper, plastics, wood and metals (aluminium, steel and copper). A new way to calculate a replacement coefficient is then proposed. The replacement coefficient defines the amount of primary material that can be replaced by one unit of waste-derived (secondary) material, when this replaces the equivalent virgin material, either in the same application or in a different application. Examples of possible values of the replacement coefficient for different materials are given. The definition of the point of substitution, i.e. the

exact point along the recycling chain where the waste-derived material can be used to substitute the corresponding primary material, is also thoroughly addressed. Different considerations can be applied to the examined materials and examples of identification of the point of substitution for the different materials are discussed.

The main conclusion of the study is that the proposed formulations of the replacement coefficient together with the definition of the point of substitution should be considered in any waste-oriented LCA study where the benefits of recycling have to be evaluated. A consistent quantification of the replacement coefficient allows for improvement of the modelling of substituted primary materials in recycling processes and consequently, the quality and robustness of conclusions and recommendations of waste-management-oriented LCA studies.

4. R1 index calculation of waste-to-energy facilities

According to Directive 98/2008/EC, the operation carried out by an incinerator of Municipal Solid Waste (MSW) is classified either as energy recovery (R1) or as disposal (D10) depending on the result achieved by the application of the R1 formula. In 2011, the DG Environment of the European Community (EC) issued some non-binding guidelines on the interpretation of such a formula that clarified many aspects related to its application. A point not fully clarified by the EC guidelines is the determination of the energy contained in the treated waste (E_w). For this term of the formula, reference is made to the indirect method for the calculation of boiler thermal efficiency, as defined by the norm EN 12952-15. However, such a norm is not directly applicable to an entire year of operation of a waste-fired boiler. For this reason, a practical method for the calculation of the E_w term has been developed in the framework of a collaboration between the MatER Study Centre and the Lombardy Region (Italy). The method is based on: (i) the identification of the most reliable data available from the Distributed Control System (DCS) of the plant; (ii) the definition of a control volume around the boiler(s) also based on the availability of data; (iii) the closure of the mass balance for such a control volume; (iv) the energy balance of the same control volume and together that gives the E_w term of the R1 formula. The method was applied in 2015-2017 to several plants, generating a number of interesting data, such as R1 index values, Lower Heating Values (LHV) of the treated wastes, main sources of energy losses in waste-fired boilers, etc. The application of the law of propagation of uncertainties, according to the ISO/IEC Guide 98-3, led to the assessment of the accuracy of the method, which resulted in an uncertainty of only a few percent at 95% confidence.

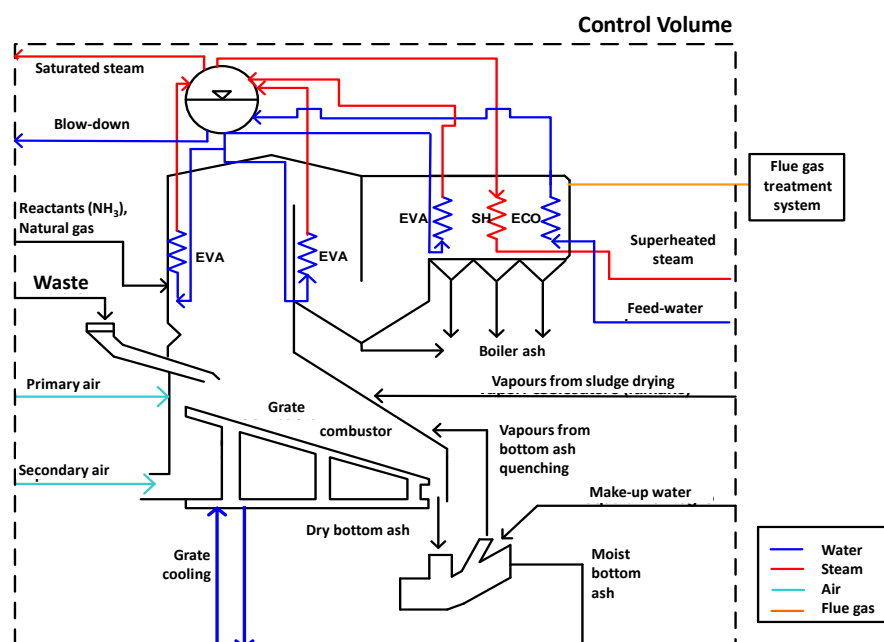

5. Measurement of ultrafine dust and nanoparticles in conveyed flows and ambient air

Ultrafine dust and nanoparticles are solid compounds of less than tenth of a micron in size, like the one of a virus (one thousands times smaller than the size of a human hair). Their contribution is negligible in terms of the total weight of atmospheric dust but it becomes significant in terms of the total quantity of individual particles. Their determination requires advanced techniques and instruments which, unlike the conventional protocols used for fine dust measurement, are based on particle counting and adopt recent systems developed after the spread of nanotechnologies.

MatER Study Center carries out experimental tests, by means of the equipment and instrumentation available at LEAP, for evaluation of emissions and the chemical characterization of ultrafine and nanoparticles from combustion processes in both fixed installations and ambient air around plant sites of interest.



UF particulate sampling system in conveyed streams

6. Experimental (by means of suction pyrometers) and theoretical assessment of post-combustion conditions in waste-to-energy plants

"The gas resulting from the incineration of waste must be raised, after the last injection of combustion air, in a controlled and homogenous fashion and even under the most unfavourable conditions, to a temperature of at least 850 °C for at least two seconds" (Art. 50 Directive 2010/75/EU). This norm, called "T_{2s} requirement", obliges all the waste-to-energy operators to continuously monitor the post-combustion conditions and to turn on auxiliary burners in the occurrence of non-compliance.

Among the activities of LEAP and MatER Study Center, there is the experimental assessment of post-combustion conditions in waste-to-energy plants through accurate flue gas temperature measurements carried out with suction pyrometers (up to 1,600 °C). By defining the temperature field inside the post-combustion zone in different operating conditions, the application of standard procedures allows the assessment of the compliance with the T_{2s} requirement.



Furthermore, since such a compliance must be verified continuously during the operation of waste-to-energy plants, LEAP and MatER Study Center have developed flexible models of waste-fired boilers that are used for the definition of optimal control algorithms. By calibrating these models against experimental data, the algorithms can estimate the T_{2s} in all operating conditions, based on monitored parameters (e.g. temperature, steam production, oxygen concentration in flue gas measured by plant instrumentation).



Gas analyser and suction pyrometer

7. Evaluation of innovative thermo-chemical waste treatment processes

In the framework of the collaboration with Lombardy Region (Italy), the MatER Study Center gives scientific support in the evaluation of some projects presented for authorisation request. All projects involving innovative thermo-chemical waste treatment processes (mainly pyrolysis- and gasification-based) are screened. After a preliminary check on the coherence of mass and energy balances, all the main aspects concerning safety of operation and environmental compatibility are considered.

8. Dedicated technologies for sewage sludge incineration

This research project, funded by a Lombardy Region (Italy) competitive grant, involves a number of companies and research bodies active in the field of wastewater treatment. LEAP and the MatER Study Center contribute to the study and the development of an efficient and environmentally friendly system for the dedicated incineration of (possibly digested) sewage sludge. Combustion greatly reduces the mass and volume of solid residues to be handled by consuming all of the organic matter. Furthermore, dedicated incineration is the most effective way of concentrating the inorganic substances contained in the sludge. For precious species, like phosphorous, recovery processes are already applicable and will be considered in the project.

9. Study on the combustive properties of solid materials

Solid waste is a mixture of many materials. Its combustion in waste-to-energy plants produces flue gases that, when discharged to the atmosphere, are the main source of environmental impact of these types of plants. Most pollutant emissions are proportional to the amount of flue gas discharged since their concentrations are controlled by flue gas treatment systems.

The amount of flue gas produced, and hence discharged, depends on the characteristics (i.e. the ultimate composition) of the treated waste. However, the specific energy content (the lower heating value) of solid materials is also strongly correlated to the same characteristics. This similarity makes the amount of flue gas discharged strictly connected to the energy released during combustion. The result is that, once the load of a plant is set, the amount of flue gas discharged can vary in a very narrow range. Therefore, in most cases, the amounts of emissions are only marginally influenced by the nature of the treated waste.

MatER Study Center has been working for many years in analysing the combustive properties of solid materials. Nowadays, it is formalizing some general conclusions on the influence of waste nature on most of the emissions of waste-to-energy plants and the consequent environmental impacts. The preliminary results show that the common perception of a strong dependence of pollutant emissions on the nature of waste has very little foundation.

10. Waste-to-liquid fuel technologies

In past decades, many technologies have been proposed for the production of synthetic liquid fuels from waste. However, none of them has been successful. In recent years, many more processes have come to market, some of them as demonstration / pilot units, others even for commercial applications. Since technological advancement has brought along a number of new possibilities, MatER is investigating the entire spectrum of proposed technologies to assess the actual potential of this energy conversion route in the current situation.

11. Communication: the new website of the MatER Study Center

Over the last year we have been working continuously on the analysis and planning of the Digital Strategy of our Study Center in our valued collaboration with Quaerys Srl (www.quaerys.com), an innovative start-up based at the University of Turin, operating in the fields of Social Media Monitoring & Analysis and Big Data Content Analysis. The purpose has been to define the communication strategy of the MatER's channels, through the re-design specifically of the MatER website, not only with a more intuitive graphical interface but with more accessible content as well. An important new feature for example is the [WikiMatER section](#) which is intended to serve as a rich encyclopaedia about all the topics related to the recovery of material and energy from waste. Please visit the new website at www.mater.polimi.it!

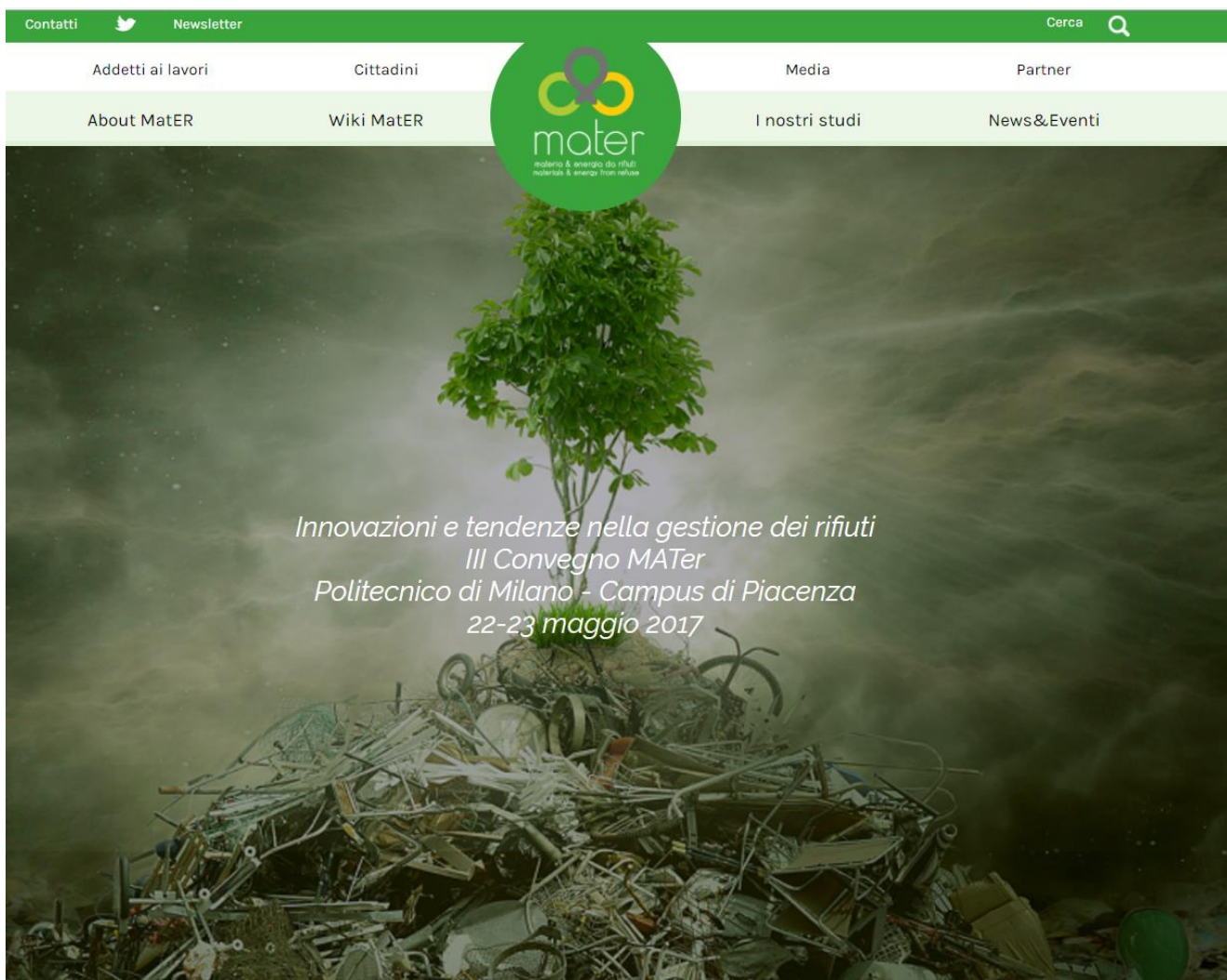

Contatti  Newsletter Cerca 

Addetti ai lavori Cittadini Media Partner
About MatER Wiki MatER I nostri studi News&Eventi



Rifiuti a colpo d'occhio Rifiutiamo le bufale



1,5 kg

media di rifiuti al giorno per italiano



45%

media dei rifiuti raccolti per via differenziata



31%

rifiuti smaltiti in discarica nel 2014



1 kg

rifiuti per alimentare una lampadina a led per 80 ore

Ciascun italiano produce in media 1,5 kg di rifiuti al giorno.

In Italia in media solo il 45% dei rifiuti è raccolto per via differenziata. Esistono tuttavia enormi differenze tra Regione e Regione.

La discarica, in Italia, è ancora l'opzione di gestione dei rifiuti a cui si ricorre maggiormente, anche se in continua diminuzione: nel 2014 il 31% dei rifiuti prodotti sono stati avviati a smaltimento in discariche.

Dalla combustione di 1 kg di rifiuti indifferenziati un termovalorizzatore ad alta efficienza può produrre sufficiente energia elettrica da alimentare una lampadina a led per 80 ore, o un ciclo di lavaggio di una lavatrice di classe A+++.

Addetti ai lavori Cittadini  Media Partner
About MatER Wiki MatER I nostri studi News&Eventi

La normativa italiana (D.Lgs. n. 152/2006) definisce rifiuto **qualsiasi sostanza od oggetto di cui il detentore si disfi, per scelta o perché obbligato dalla legge a farlo**.

L'elenco dettagliato dei rifiuti e la loro classificazione sono **stabiliti per legge** e aggiornati periodicamente. La produzione totale di rifiuti in Italia si attesta intorno a **160 milioni di tonnellate all'anno**, corrispondenti all'incirca a **2.600 chilogrammi per abitante per anno**. I rifiuti possono essere classificati secondo due modalità, ovvero *in base alla loro origine o in base alla loro pericolosità*.

La classificazione **in base all'origine** prevede:

- Rifiuti Urbani (RU)
- Rifiuti Speciali (RS)

La classificazione **in base alla pericolosità** prevede:

- Rifiuti pericolosi
- Rifiuti non pericolosi

Fonte dati: Ispro 2014, 2015

PRODUZIONE DI RIFIUTI IN ITALIA		2013
Rifiuti urbani		29.594.665
Rifiuti speciali non pericolosi		122.949.829
Rifiuti speciali pericolosi		8.656.767
TOT		141.203.274



La distinzione **rifiuti urbani/speciali** e **rifiuti pericolosi/non pericolosi** ha effetti su molte procedure tecniche legate alla gestione, come autorizzazioni, obblighi di registrazione e comunicazione annuale, individuazione del soggetto che ha il compito di provvedere al loro smaltimento, divieto di miscelazione e sistema delle sanzioni, e via di seguito. Le singole classi di rifiuto sono codificate in base al **Catalogo Europeo dei Rifiuti (CER)** in vigore. Codice a sei cifre delle quali le prime due individuano il capitolo, le seconde due il sottocapitolo e le ultime due lo specifico rifiuto.

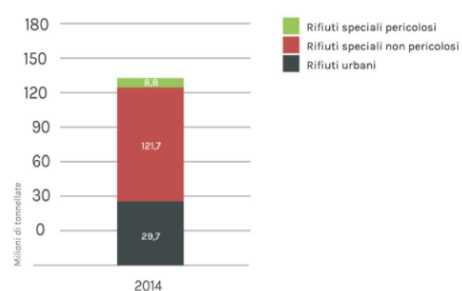

Addetti ai lavori
About MatER

Cittadini
Wiki MatER



Media
I nostri studi

Partner
News&Eventi

Composizione merceologica

La composizione merceologica classifica i componenti sulla base di **caratteristiche fisiche macroscopiche rilevabili visivamente**



Composizione merceologica

La composizione elementare classifica i componenti sulla base della **composizione chimica, rilevata con prove di laboratorio**



Solidi volatili

Atomi C, H, O, N, S, Cl, F, etc.
(PCI > 0)

Umidità
(PCI < 0)

Ceneri
(PCI = 0)

La [Direttiva 2008/98/CE](#) del Parlamento Europeo e del Consiglio dell'Unione Europea stabilisce la «gerarchia dei rifiuti», ovvero l'ordine di priorità da attuare per la prevenzione e la gestione dei rifiuti.

Le fasi previste sono le seguenti:

- Prevenzione
- Preparazione per il riutilizzo
- Riciclaggio
- Recupero di altro tipo, ad esempio il recupero di energia
- Smaltimento

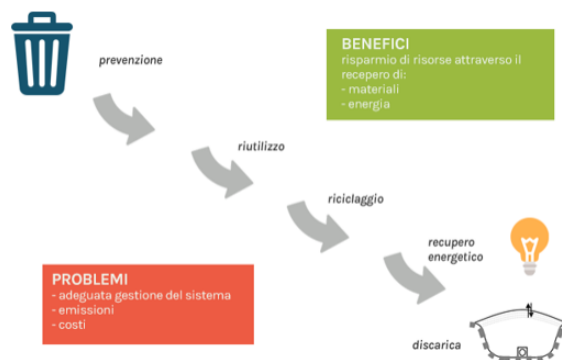

MATER STUDY CENTER

via Nino Bixio 27/c, 29121 Piacenza (Pc) - Italy

Tel. +39 0523.356886
Fax +39 0523.623097

Email: mater@polimi.it

Web site: www.mater.polimi.it